



origin

DOORS AND WINDOWS

Internal Door (OI-30)

Technical Specifications & Installation Guide



Contents

Specification Overview	3
Optional Extras	4
Internal Door Make Up	8
Master Configurations	9
Technical Drawings	11
Handle Styles	26
Popular Configurations	32
Internal Door Styles	33
OI-30 Installation Guide	34
Accreditations	38

Specification Overview

Profile Specification

Frame Depth	40mm
Frame Width	30mm
Sash Depth	32mm
Width	30mm
Glass Divide Depth	31mm
Glass Divide Width	35mm
Threshold clearance	10mm
Corner Post	47mm depth x 47mm width

Features

- ▶ Up to a 20-year guarantee**
- ▶ Corner configuration available
- ▶ 35mm glazing bar
- ▶ Square or chamfered bead option
- ▶ Coupling available

Options and extras

- Flexible design options – can be a combination of fixed, single, French or corner doors
- Accommodates 4mm, 6mm and 6.8mm glazing
- Purpose-designed corner post
- Up to six horizontal and two vertical splits
- Lock block available with or without locking
- Turn and release lock
- Kickplate or panels available
- Five handle options to choose from
- Hinge colours: black, satin brass, polished brass, satin stainless
- Half rose door stop colours: matt black, matt bronze, antique brass, satin brass, satin nickel
- 15mm frame extender
- Square or chamfered bead

Lead Times

- ▶ The Origin Internal Door is made completely bespoke to your exact requirements and is available in within five working days
- ▶ Available colour – 9005M

Optional Extras

Bead

The OI-30 can be specified with either a square bead or chamfered bead. The two options offer a different aesthetic, with the square being more traditional but not detracting from being fit for purpose for modern/modern contemporary spaces. The two options also tie in with all our other products so you can match or contrast bead options to the rest of the Origin product suite.

Frame Extender

The 15mm frame extender on the OI-30 allows you to increase the width of your door or fixed frame.

- NB: The frame extender can only be used as side flags to the left or right of the configuration

Handles

Choose from a selection of elegant handle styles that have been designed and manufactured with the same care and dedication as every other door component.

There are five handle ranges available, the Standard, Contemporary, Signature and the Heritage Handle Ranges.

Standard Handle

The Standard handle offers a simple yet striking look and is available in black

Contemporary Handle

The Contemporary Handle range is available in matt and satin finishes which include Antique Brass, Matt Black, Matt Bronze, Satin Brass and Satin Nickel.

Signature Handle

The Signature handle is a statement piece with its knurled finish. The handle is available in Antique Brass, Matt Black, Matt Bronze, Satin Brass and Satin Nickel.

Heritage Classic Handle Range

Paying homage to the traditional steel-look door, we have two Art Deco style iron handles which are available in matt black and hammered pewter

Heritage Edged Handle Range

With a similar style to the Heritage Classic, this handle has much more squared off features. It's also available in matt black and hammered pewter



Signature Knurled Handle

- Antique Brass*
- Matt Black
- Matt Bronze
- Satin Brass
- Satin Nickel

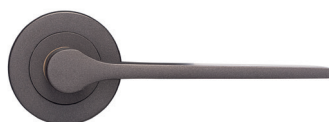

Contemporary Handle

- Antique Brass
- Matt Black
- Matt Bronze*
- Satin Brass
- Satin Nickel



Standard Handle

- Matt Black*

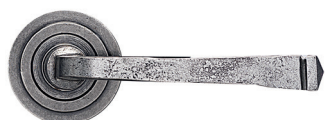

Heritage Classic Handle

- Hammered Pewter*
- Matt Black

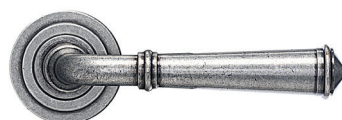

Heritage Edged Handle

- Hammered Pewter*
- Matt Black



*Handle colour shown.

Turn and Release

Our turn and release locks are available to match our handle suite and are available in Antique Brass, Matt Black, Matt Bronze, Satin Brass and Satin Nickel.

Turn and Release



Antique Brass



Matt Black



Matt Bronze



Satin Brass



Satin Nickel

Door Stops

A convenient feature, these door stops are available in Antique Brass, Matt Black, Matt Bronze, Satin Brass and Satin Nickel.

Half Rose Door Step



Antique Brass



Matt Black



Matt Bronze



Satin Brass



Satin Nickel

Hinges

The OI-30 hinges are available in, Black, Polished Brass, Satin Brass and Satin Stainless. They also come with a subtle copper accent which accentuates both the door and hinge.

Hinges



Black



Polished Brass



Satin Brass



Satin Steel

Glazing Options

The OI-30 can accommodate 4mm, 6mm or 6.8mm glazing units and dependent upon your specific needs.

Kickplates and panels

You can specify your doors to come with solid plain black panels which can offer added privacy depending on where the doors are being installed. Alternatively, kickplates are available, which will allow your client to nudge the door open with their foot.

N/B

- When you specify a corner configuration, it comes with a purpose-designed corner post which is made specifically for your door
- Additionally all configurations can be coupled together to make a larger configuration or fit into a larger aperture

Option	Single	French	Corner	Fixed
Latch (Lead Door)	✓	✓	✓	x
Turn and Release (Lead Door)	✓	✓	✓	x
Fingerbolt (Slave Door)	x	✓	✓	x
Dummy Handle (Slave Door)	x	✓	✓	x
Fixed Above	✓	✓	✓	✓
Kickplate	✓	✓	✓	✓
Panel	✓	✓	✓	✓
Vertical Divides	✓	✓	✓	✓

Internal Door Make-Up

Min/Max Dimensions	Fixed Frame (mm)	Single Door (mm)	French Door (mm)
Min Sash Width	N/A	300	300
Max Sash Width	N/A	1000	1000
Min Frame Width	300	346	660
Max Frame Width	2000	1046	2060
Min Sash Height	N/A	1500	1500
Max Sash Height	N/A	2500	2500
Min Frame Height	300	1533	1533
Max Frame Height	3000	3000	3000

Specification	
Number of splits	0, 1, 2, 3, 4, 5, 6
Max panel height	900mm
Min panel height	200mm
Min Fixed Above height	200mm
Fixed above, number of splits	0, 1, 2, 3, 4
Fixed above, min centres	250mm
Max sash Weight	120Kg
Spindle height range	800-1050mm

Limitation: Doors cannot be positioned next to another door

Master Configurations

Master Configuration: OI-30

Master Configuration: Single Door

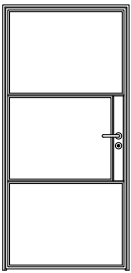

SINGLE DOOR

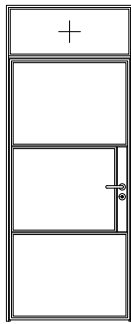

SINGLE DOOR
WITH FIXED ABOVE

Key Features:

- Up to six horizontal splits
- Can feature two vertical splits
- Can accommodate kickplate or panel

- Can accommodate kickplate or panel

Master Configuration: Door to Sidelight

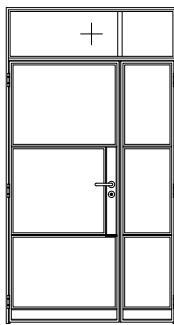
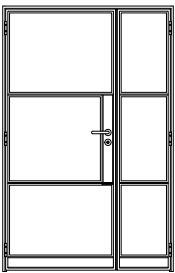

Key Features:

- Up to six horizontal splits
- Can feature two vertical splits
- Can accommodate kickplate or panel

Master Configuration: French Door

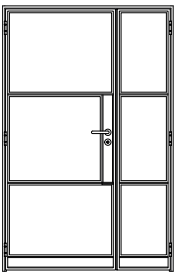

FRENCH DOOR

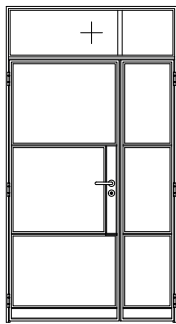

FRENCH DOOR
WITH FIXED ABOVE

Key Features:

- Up to six horizontal splits
- Can be specified with a dummy handle
- Can feature two vertical splits
- Can accommodate kickplate or panel

- Can accommodate kickplate or panel

Master Configuration: Fixed Frame

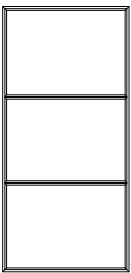

FIXED FRAME

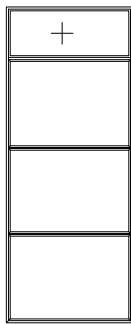

FIXED FRAME
WITH FIXED ABOVE

Key Features:

- Up to six horizontal splits
- Can feature two vertical splits
- Can be coupled to a fixed frame
- Can accommodate kickplate or panel

Technical Drawings

Concealed Coupler

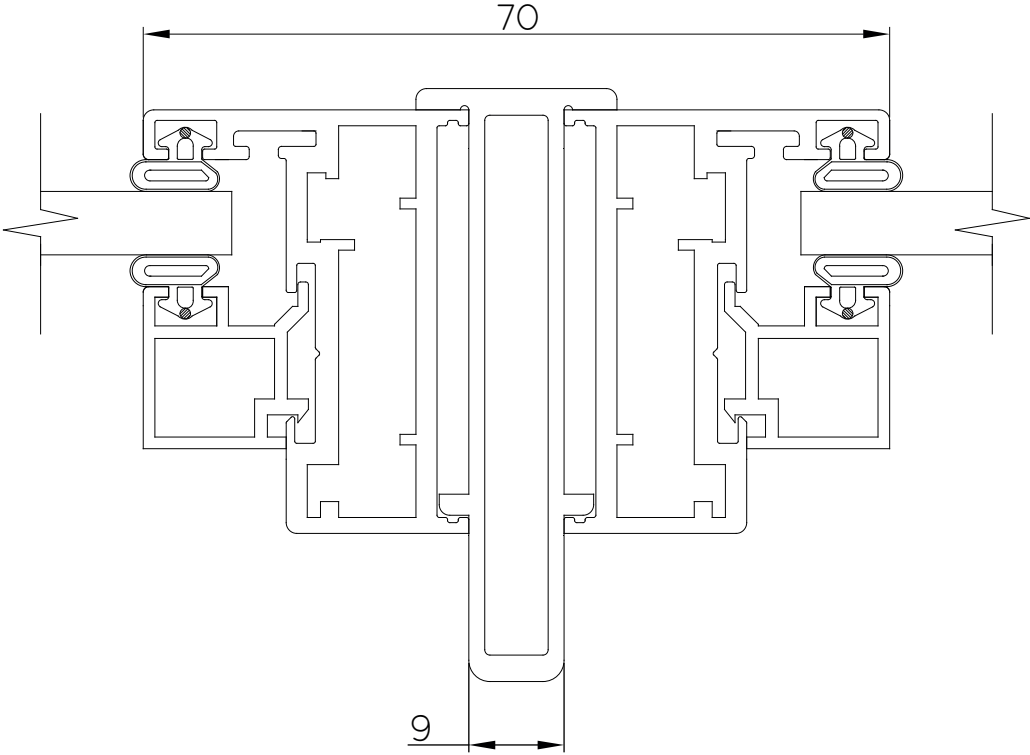
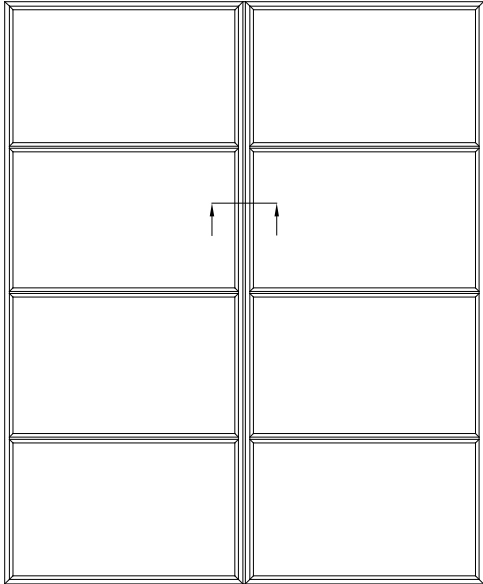

Technical Drawings

Door-Fixed Light Above Head

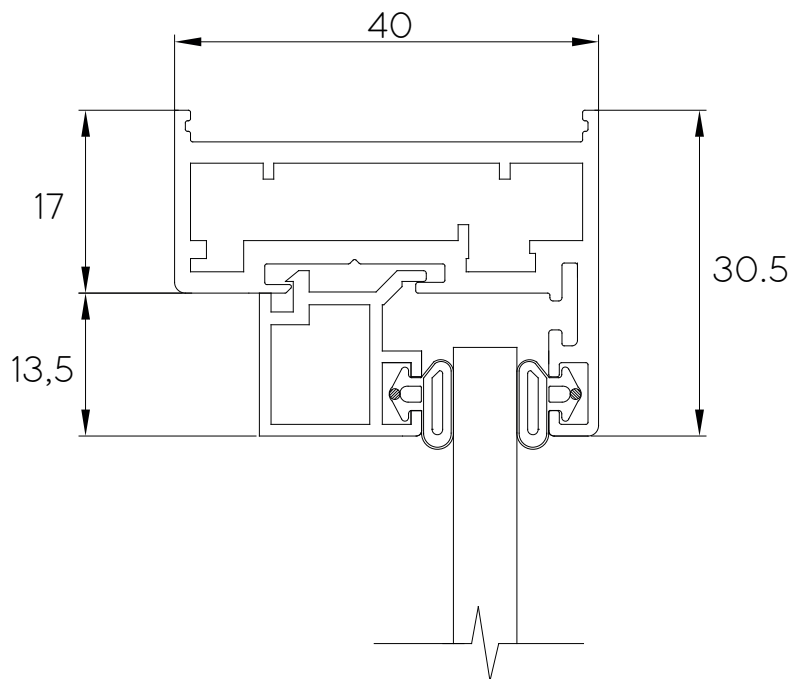
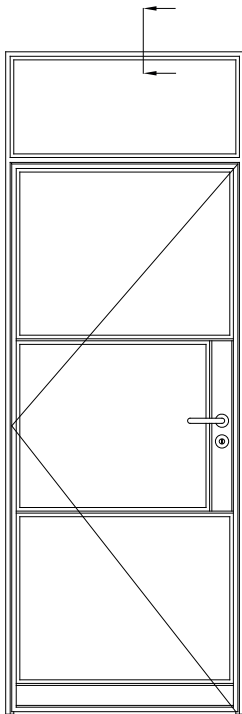

Technical Drawings

Door-Fixed Light Above

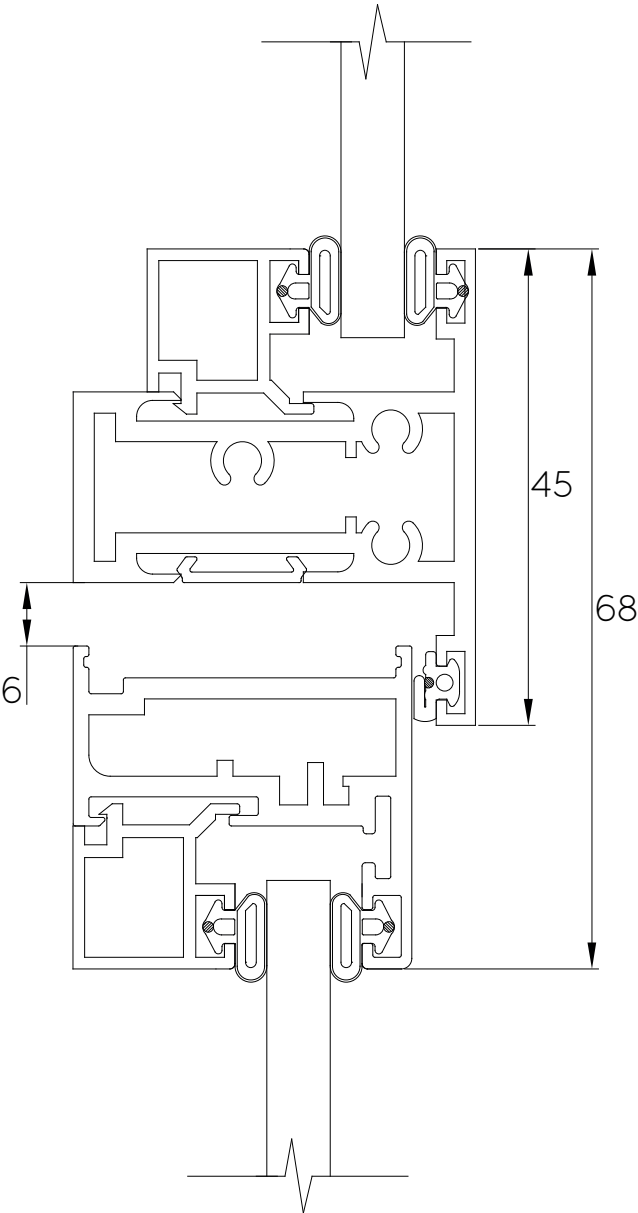
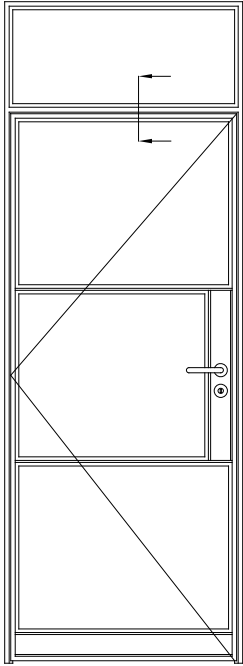

Technical Drawings

Door-Horz Glass Divide

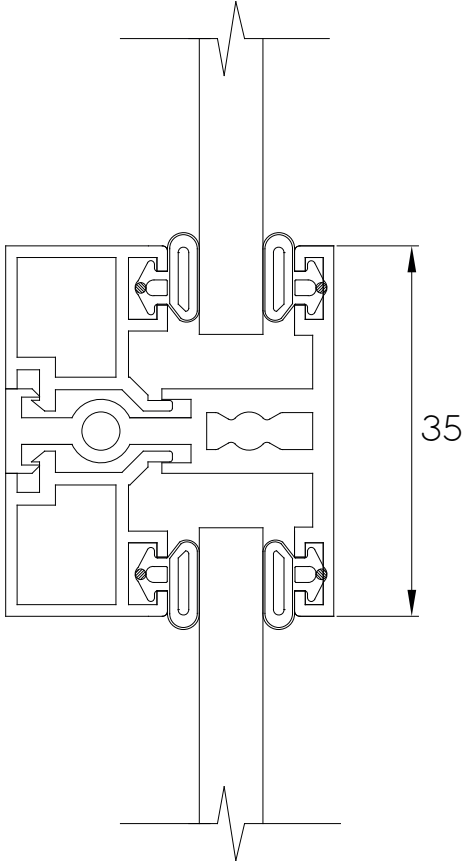
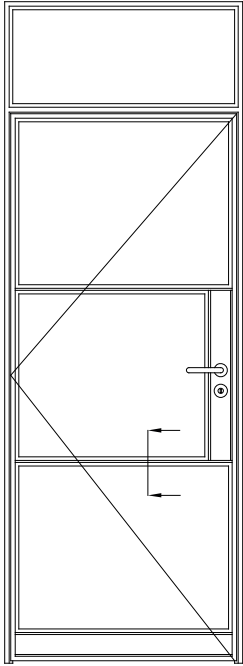

Technical Drawings

Door-Jamb

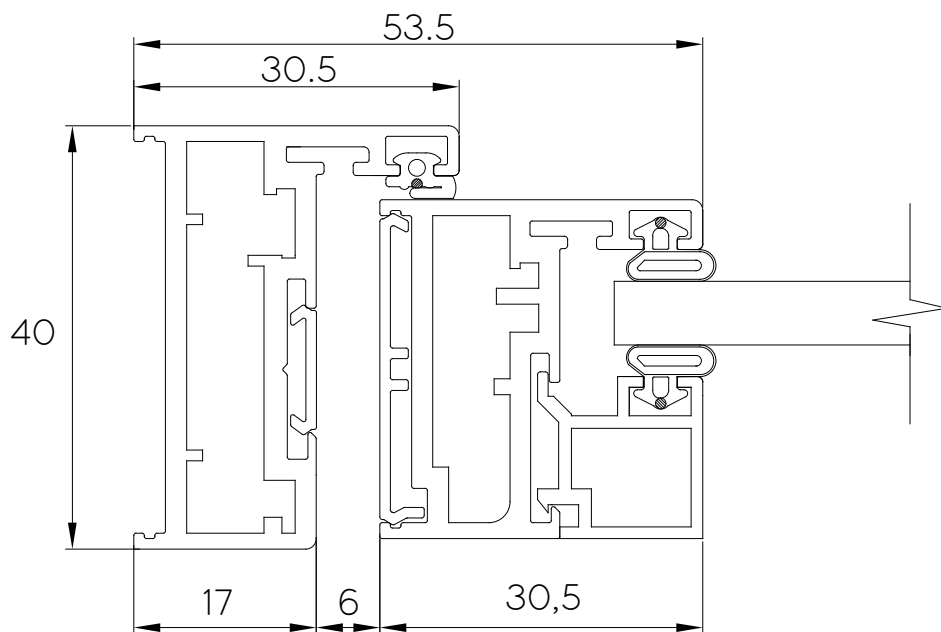
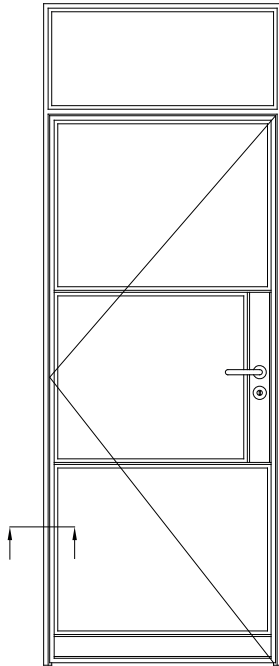

Technical Drawings

Door-Lockblock

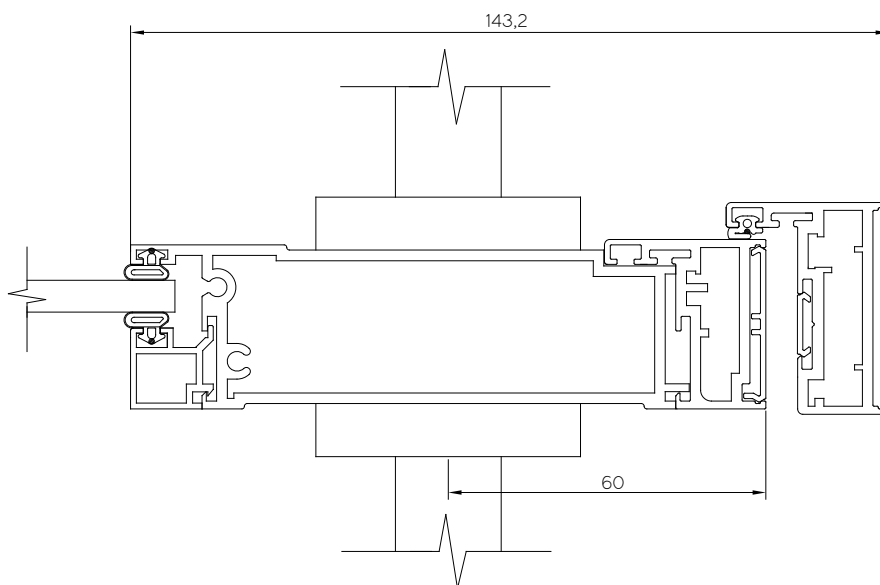
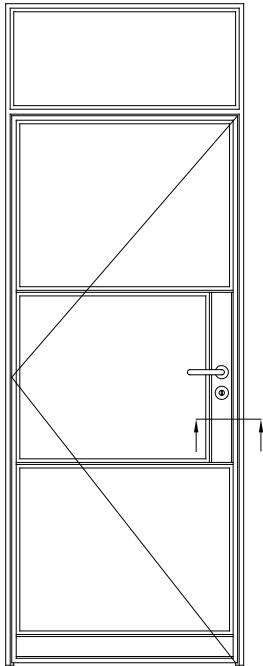

Technical Drawings

Door-Threshold

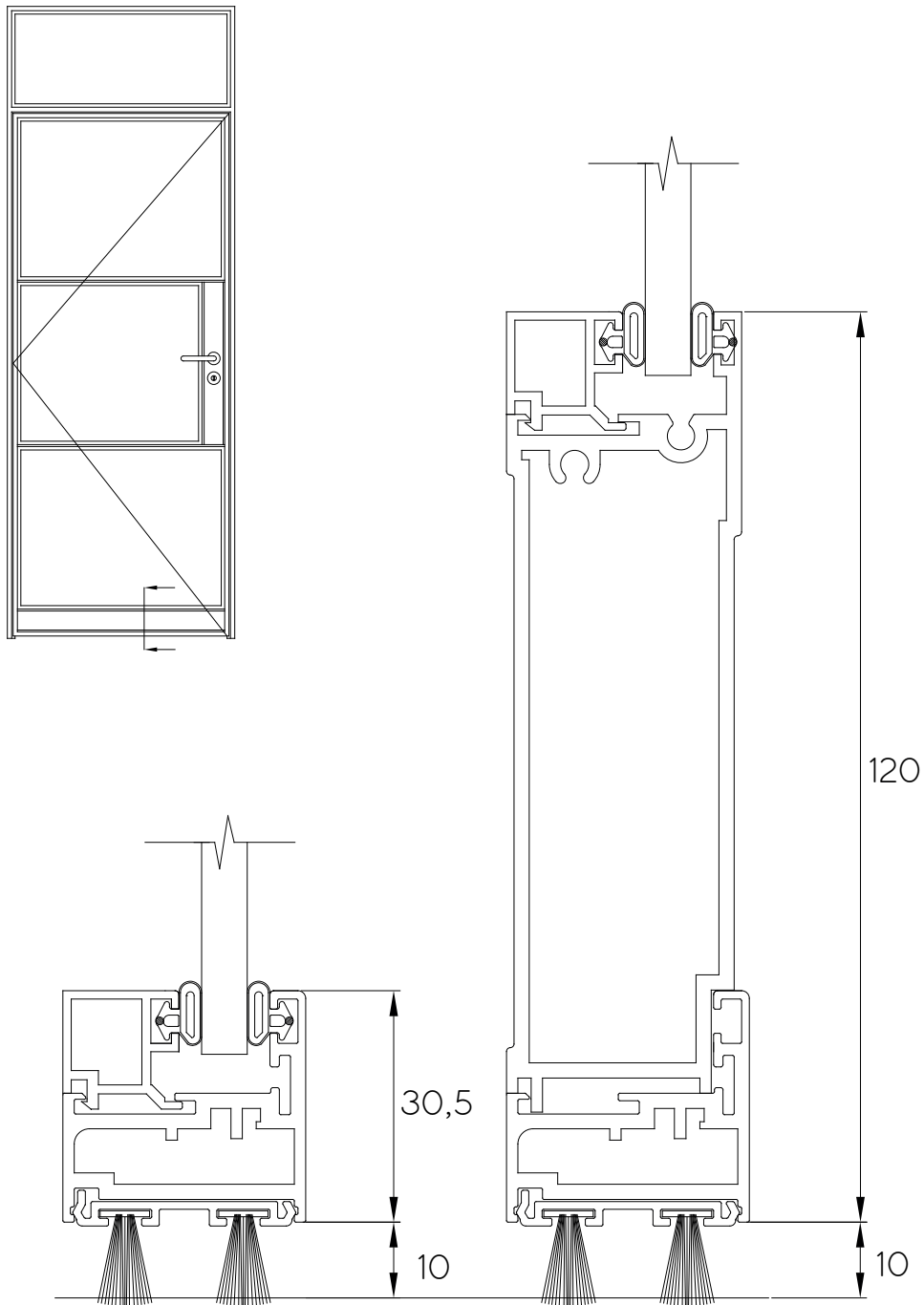

Technical Drawings

Door-Vert Divide

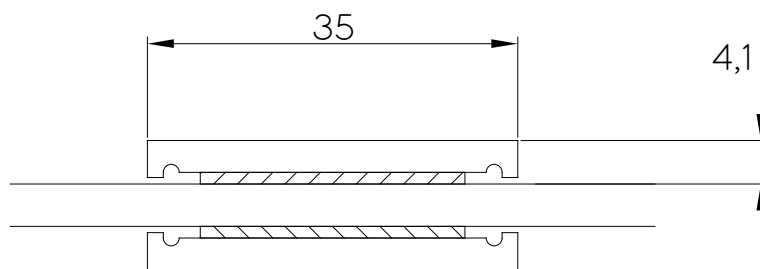
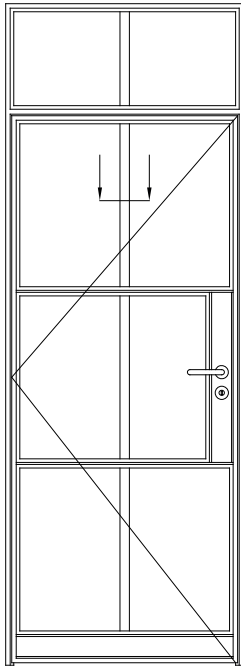

Technical Drawings

Fixed Frame-Frame

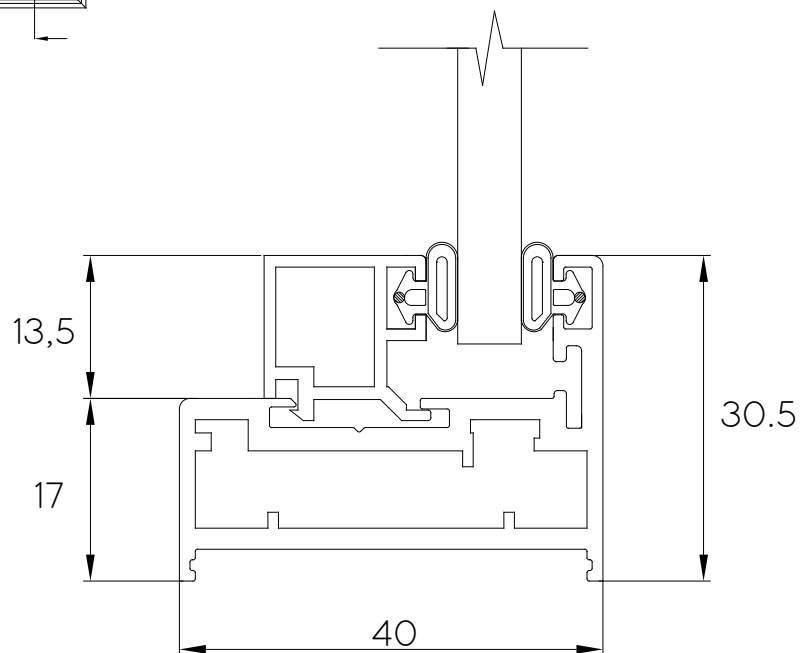
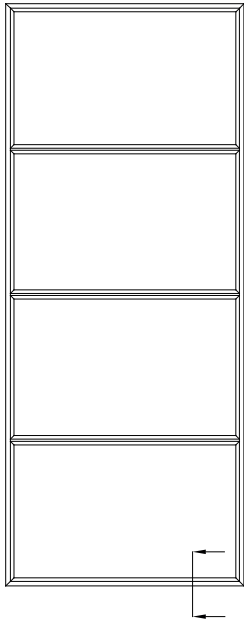

Technical Drawings

Fixed Frame-Horz Glass Divide

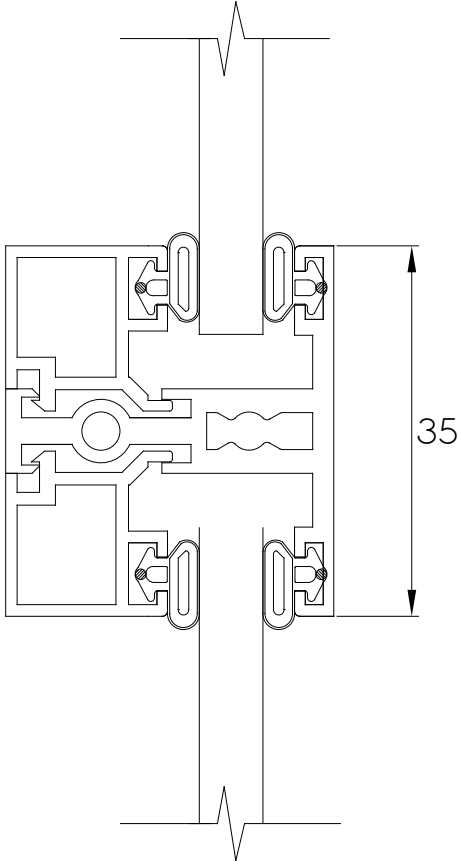
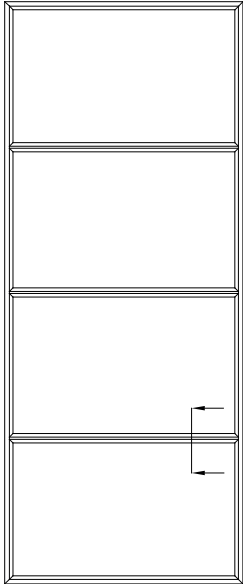

Technical Drawings

Fixed Frame-Vert Divide

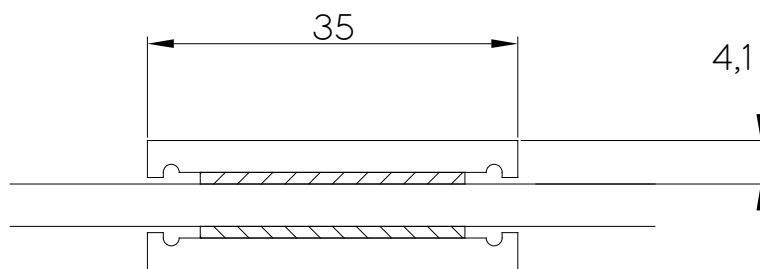
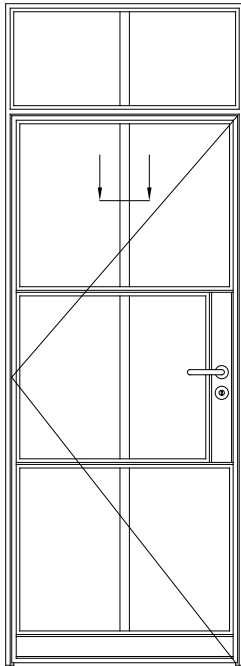

Technical Drawings

French-Meeting Stiles

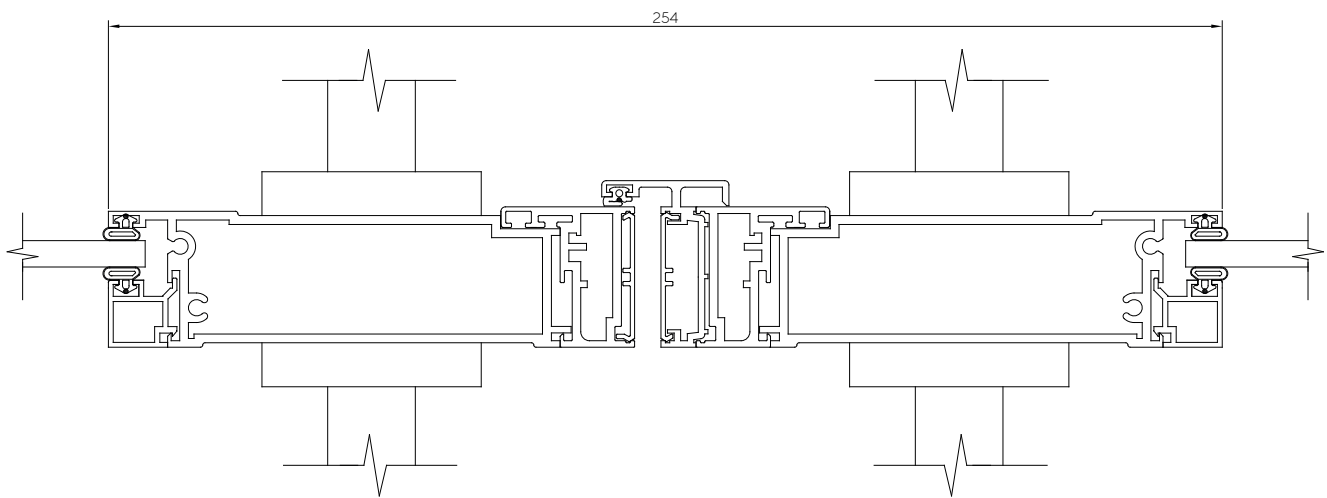
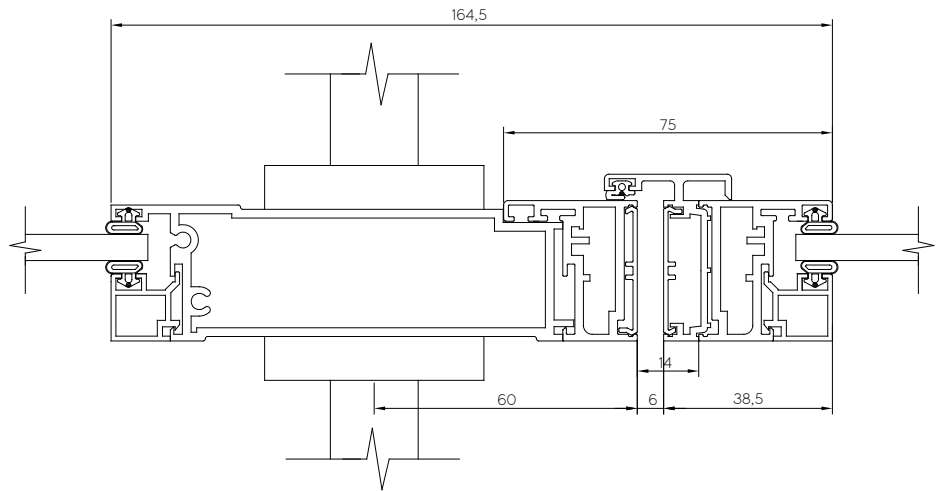
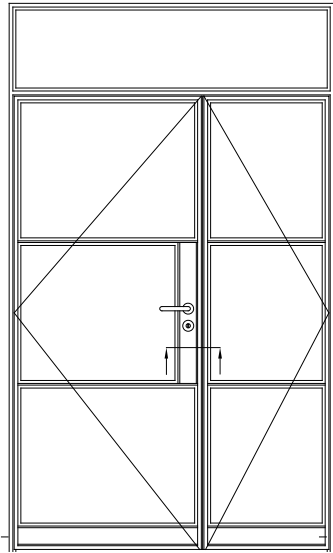

Technical Drawings

French-Vert Divide

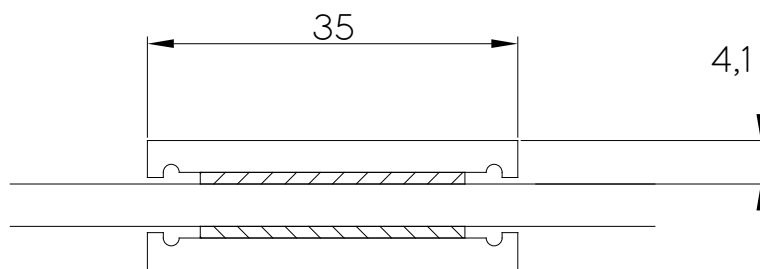
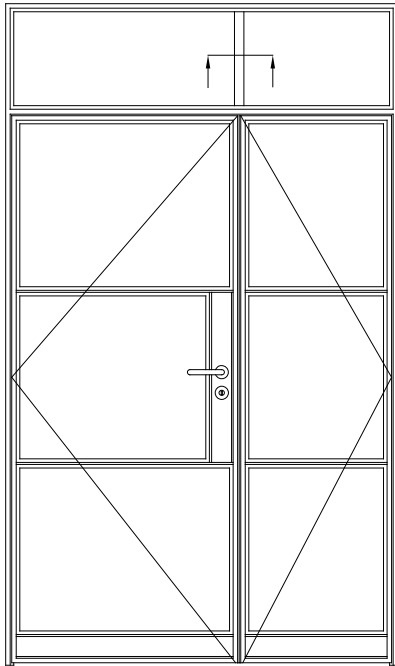

Technical Drawings

T-Coupler [Frame to Door Jamb]

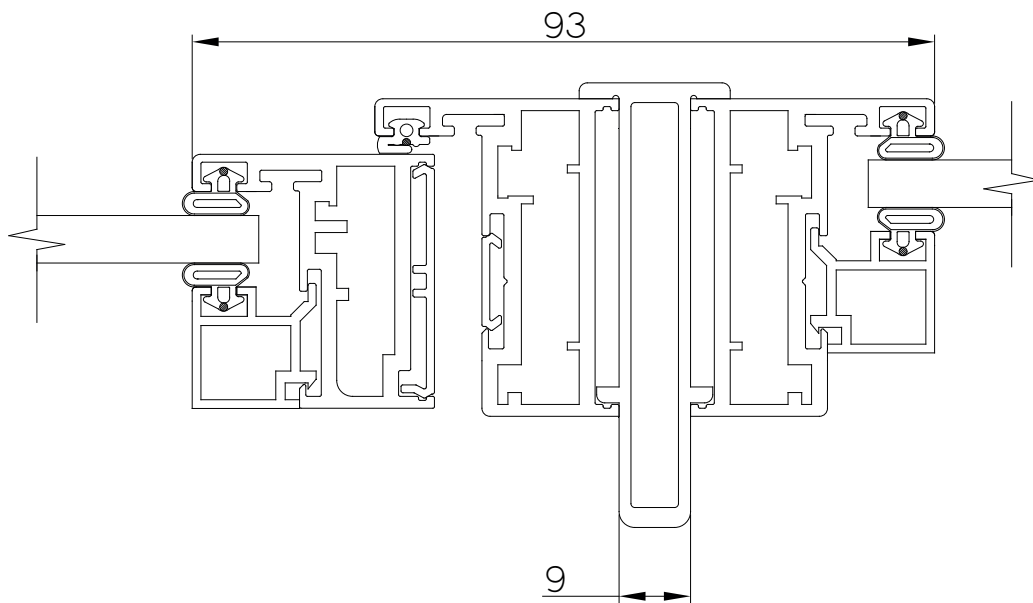
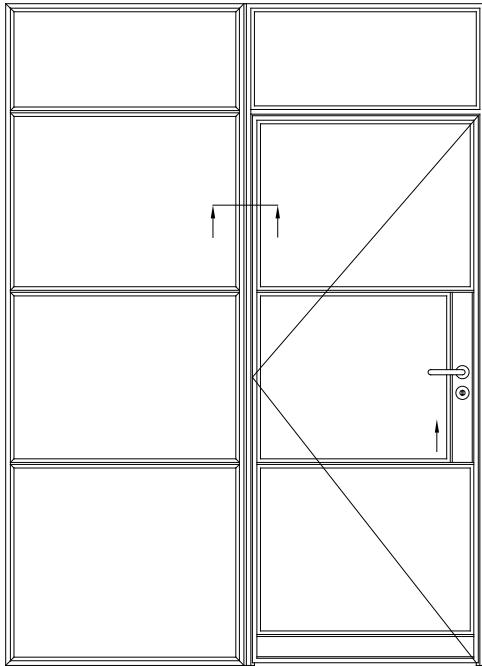

Technical Drawings

T-Coupler -Frame to Frame

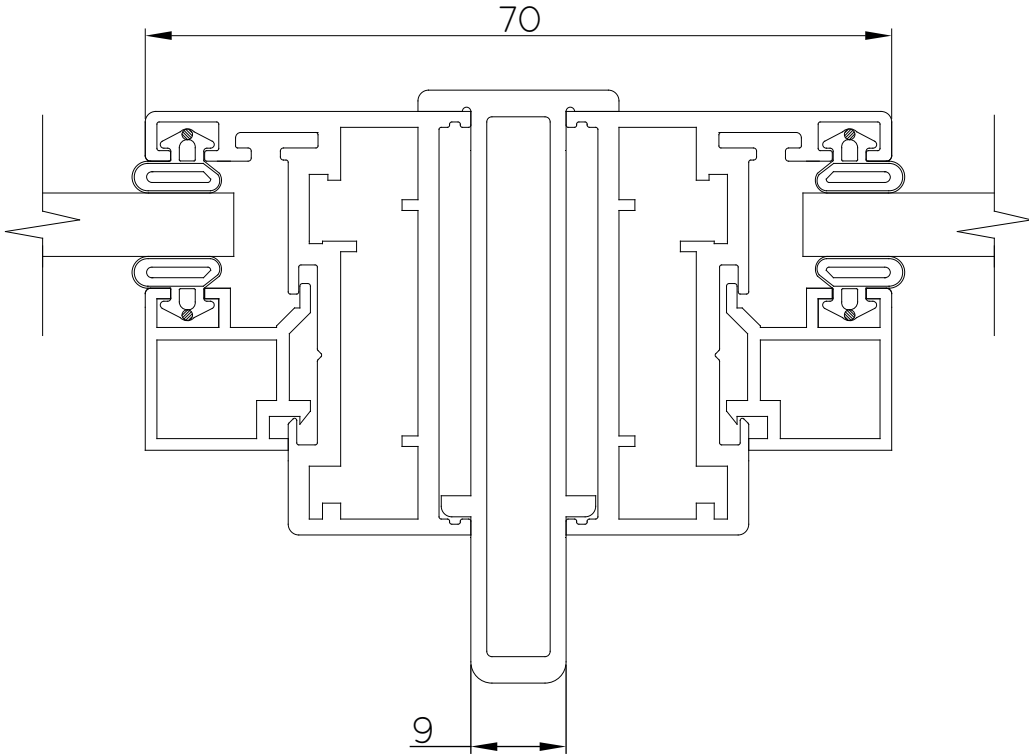
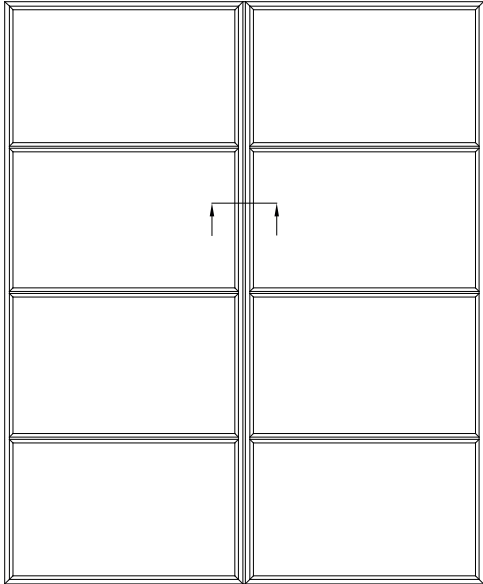

Handle Styles

Configuration Key

Signature Knurled Handle

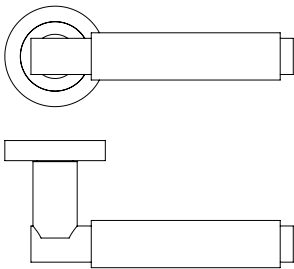

See page 27

Contemporary Handle

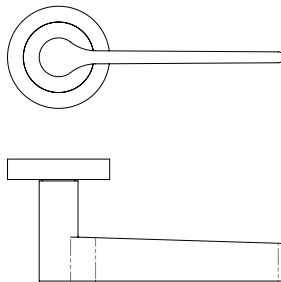

See page 28

Standard Handle

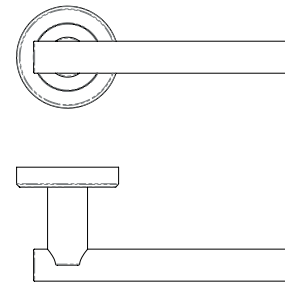

See page 29

Heritage Classic Handle

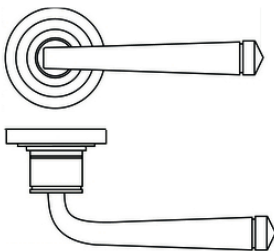

See page 30

Heritage Edged Handle

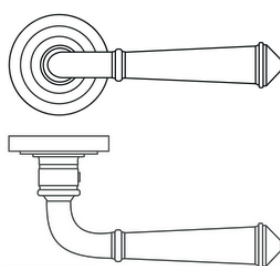

See page 31

Signature Knurled Handle

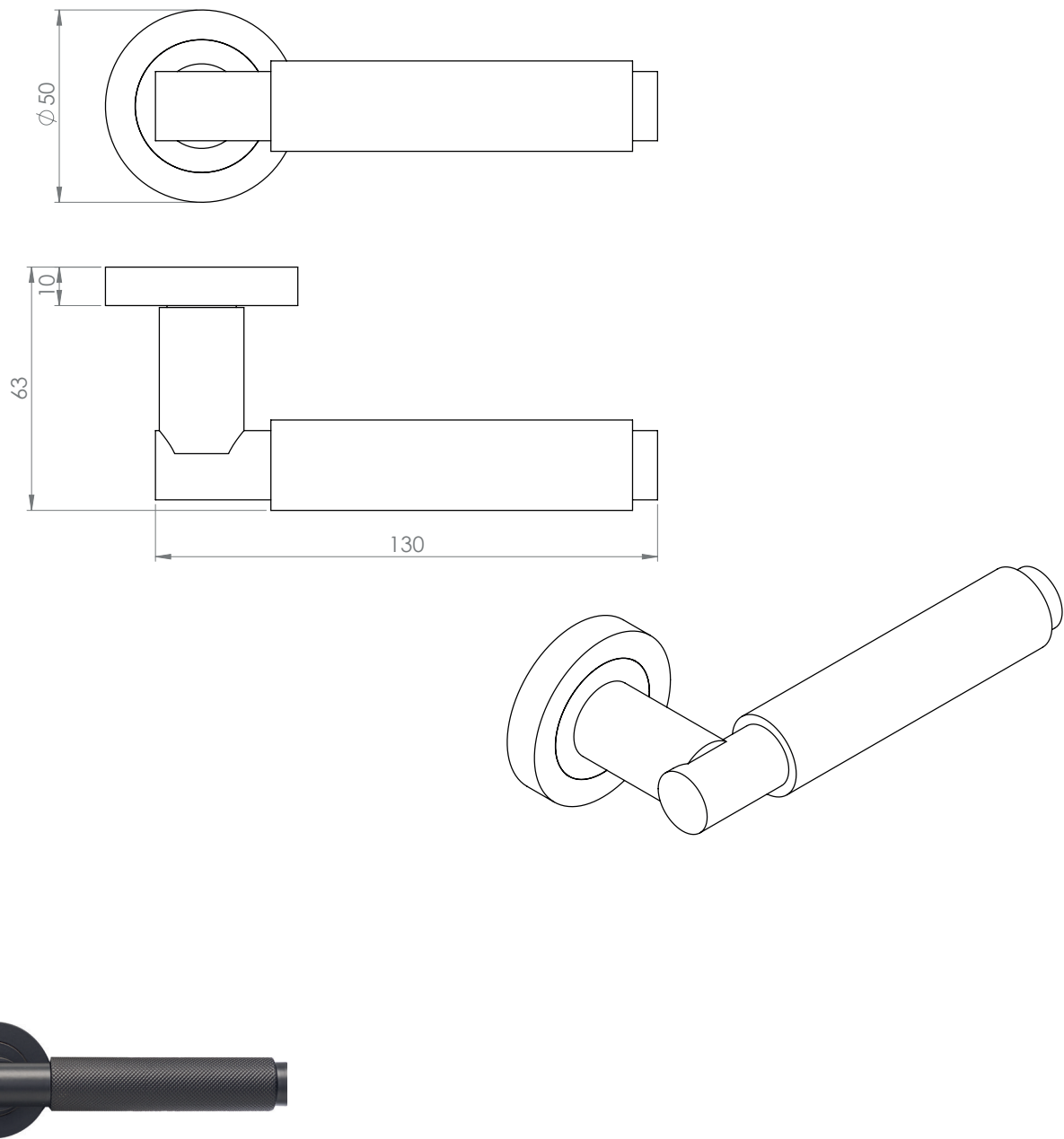

Contemporary Handle

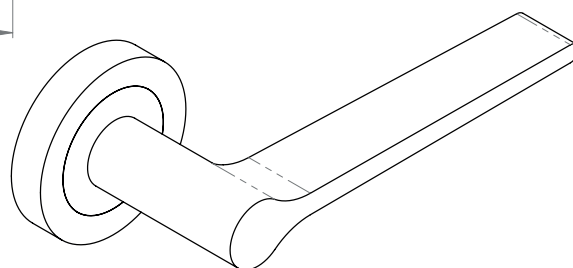
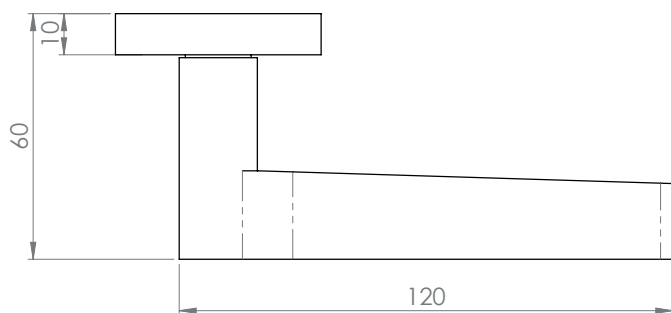
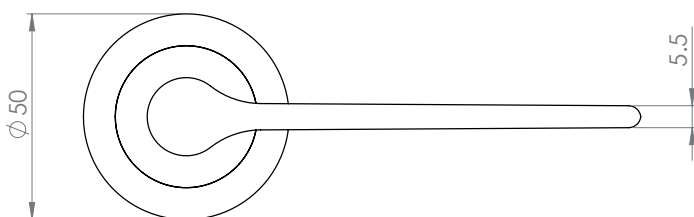

Standard Handle

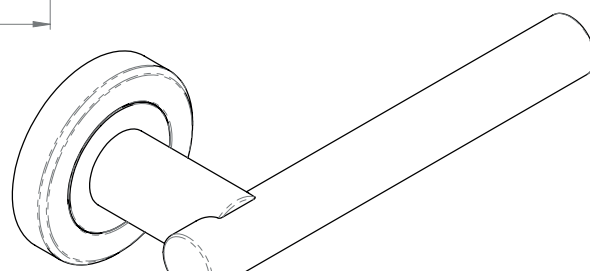
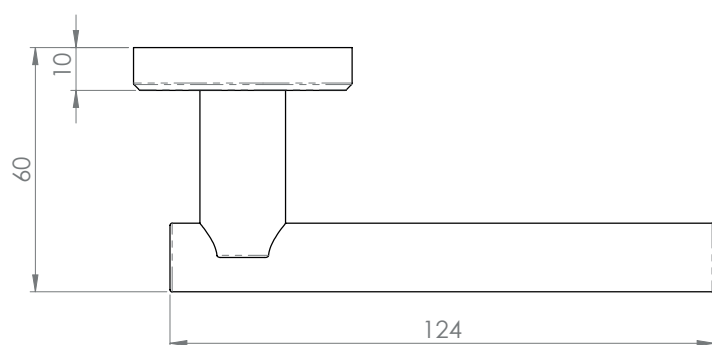
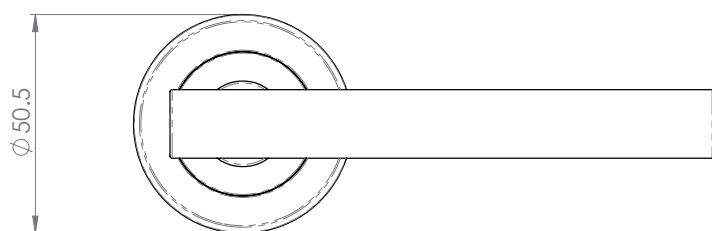

Heritage Classic Handle

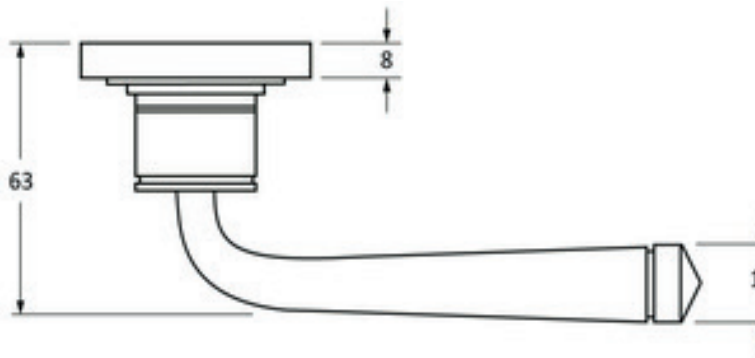
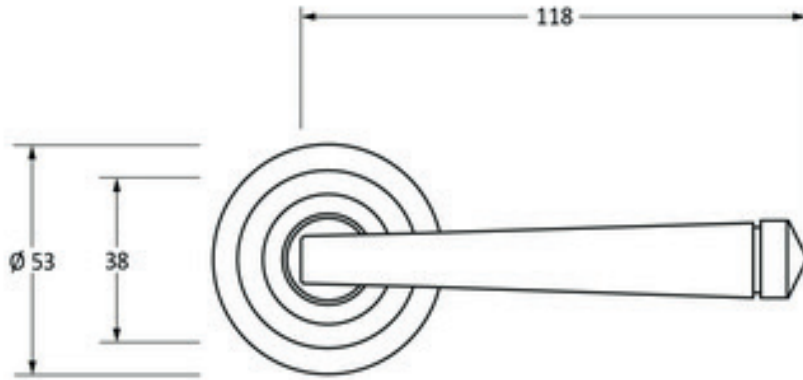

Heritage Edged Handle

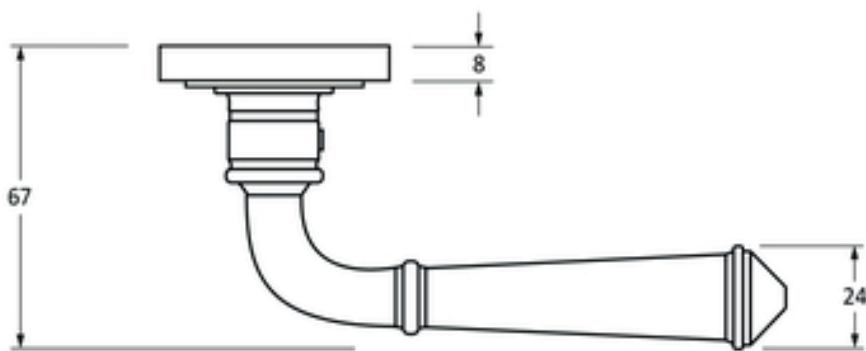
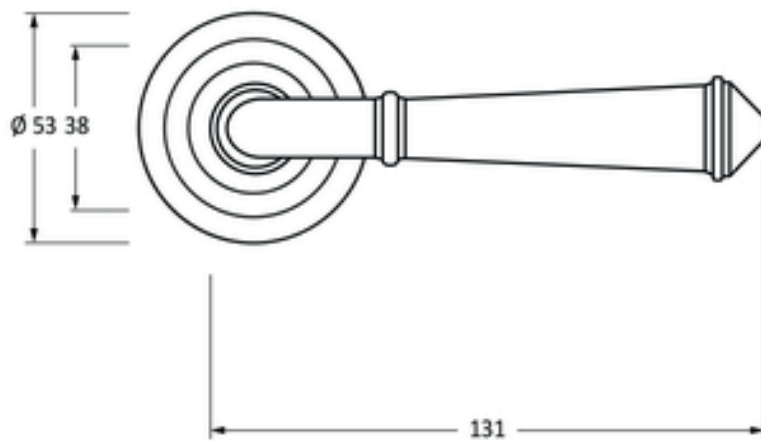

Popular Configurations

Single Door

Single Door with One Sidelight

French Door

French Door with One Sidelight

French Door with One Sidelight and Fixed Above

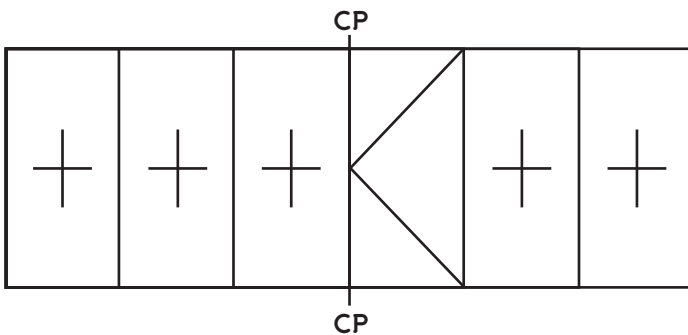
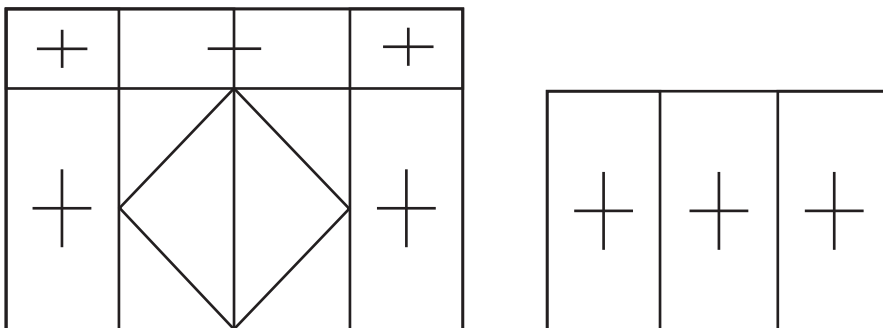
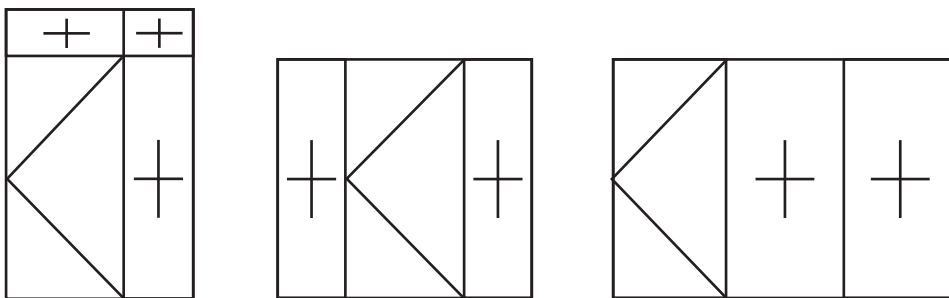

Internal Door Styles

Key:

H - Horizontal

V - Vertical

	0 H	2 H	1 V	3 H	1 V	4 H	1 V
Fully Glazed							
Kick Plate							
Panel							

	2 V	5 H	1 V	2 V	6 H	1 V	2 V
Fully Glazed							
Kick Plate							
Panel							

O1-30 Installation Guide

1. Check the frame

(open-in only)

- ▶ Unwrap product and check the following - any damage, specification and measure the width and height to ensure it fits the aperture. The transit strap will need removing from any door set.
- ▶ After measuring the frame and the opening, cut any add-ons to length.

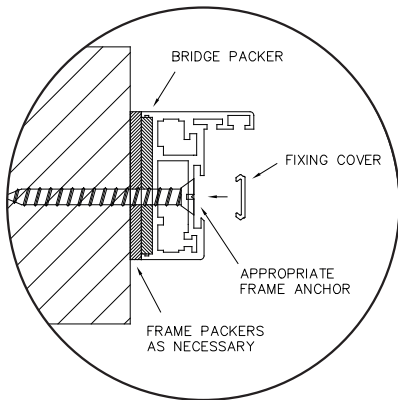

2. Prepare the frame

- ▶ In the presence of skirting boards, cut down the add-on to meet the top of the skirting and fit the frame
- ▶ Next to each fixing point around the outer frame, pack out the frame with 3mm bridging packers
- ▶ Place packers in the following locations around the exterior of the frame:
 - ▶ Hinge style - 100mm either side of hinges
 - ▶ Locking style - between 50mm and 150mm from internal corner or bottom of the frame, then no more than 600mm apart and either side of the lock plate
 - ▶ Door head - between 50mm and 150mm from internal corner and on French doors, either side of the shootbolt hole
 - ▶ Fixed frames - at the locking style and top and bottom
- ▶ If coupling frames together, then there is no need for bridging packers within the coupled sections.
- ▶ Determine your finished floor height and lift the frame into place. Pack up the frame, allowing a minimum of 10mm under the door sash at its highest point. Level and square the frame by adjusting the packing of the bridging packers.
- ▶ Starting with the hinge side, drill appropriate hole and counter sink or counter bore through the first skin of the frame for the fixing you are using (either through the packing or just to the side of it). Make sure that the fixings are tight and sit flush with the frame. Then bring the sash level to the locking style and fix as above, making sure that the frame is parallel with the sash. (See diagram 1)
- ▶ For French doors, start with the slave side then follow the above steps. The same if you have a fixed light.
- ▶ On the fixed windows, the beads will need to be removed by pushing them in toward the frame (see diagram 2) or with a stiff sharp-edged scraper. (Mark the beads on the concealed side so that you know where to refit them). Windows will need to be fixed along the bottom.

3. Coupling

- ▶ There are two coupling options. A concealed coupler that is only used for joining fixed windows up to 1800mm or a T-Coupler which is not limited in its use.
- ▶ T-Coupler - using the supplied coupler, clamp the product either side of the coupler, making sure that the coupler sits flush at the top, bottom and back of the frame. (See diagram 3) Drill and counter sink holes through the coupler and into the first skin of the opposite frame using the supplied 32mm self-tapping screws. Follow the same fixing process as you would to fix the frame into the opening.
- ▶ Concealed Coupler – align and clamp the two frames together, with the coupler sandwiched between the two frames. Drill, countersink and fix down the length of the frame, using the supplied 3.9 x 25mm fixings. Follow the same fixing process as you would for fixing the frame into an opening. (See diagram 4)

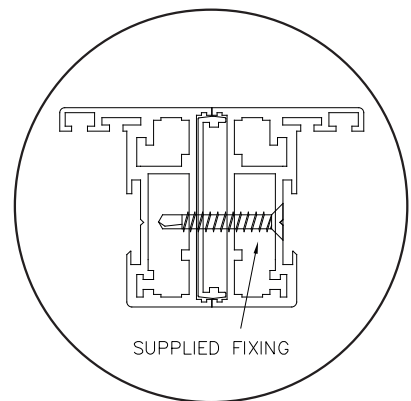
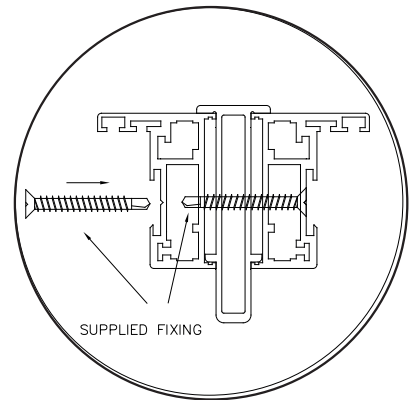
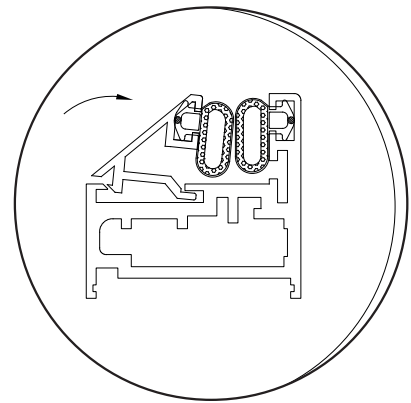

4. Glazing

Fixed frame panels:

- ▶ Using the 4mm glazing packers provided, pack out the bottom edges of the frame in each corner. Lift the glass on to the packers and clip the bottom bead into the fixed panel, followed by the top bead, and finally the side beads. Take care to avoid scratching the frame edges during installation. The beads may require a gentle tap with a rubber mallet to fix them in place, as these are knock in beads with the gasket pre-applied. If necessary, you may need to pack the glass in level down the sides to centralise the unit.

Note:

- ▶ To comply with BS 6180:2011 Barriers in and about buildings - code of practice, fixings will need to be no more than 300mm apart and fixed through both sides of each frame, making sure that all fixings are countersunk and flush.

5. Sashes

- ▶ All sashes will need to be toe and heeled, and each individual section will need to be toe and heeled. Using the glazing packers provided, place a packer on the bottom hinge side. Place the glass on to the packer and clip in the bottom bead.
- ▶ The unit then needs to be toe and heeled, starting at the bottom hinge corner, followed by the opposite top corner. (See diagram 5)
- ▶ Repeat process for all other glazed or panelled sash sections.

Handles and thumb turn lever:

- ▶ You may need to work out and cut the spindle length and screws to the correct length. The necessary dimensions are as follows:
 - ▶ 40mm screws for the handles and turn and release
 - ▶ Visible spindle length of turn and release at 50mm
 - ▶ Spindle length of 90mm for handle
 - ▶ Instruction booklet included for Anvil handle and thumb turn
- ▶ Push the spindle with the spacer into the locking mechanism. Place the female ends of the book end screws into the handle and push these over the spindle. Push the other half of the handle on to the spindle, pushing the screws through into the female screw ports of the handle. These can then be tightened up, with care taken not to strip the threads.
- ▶ Tighten up the grub screws on the handle to prevent this from coming loose. Screw the rose covers on to the handle.
- ▶ This same process applies to fitting the thumb turn lock if supplied.
- ▶ If you need to adjust the locking of the door, use a flat headed screwdriver to pry the tab on the lock keep to the correct closing and locking operation.

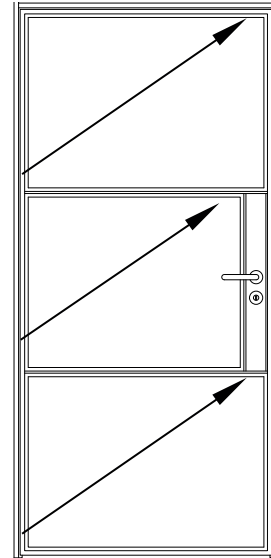

Shootbolt keep:

- ▶ Check first to ensure there is no danger to any underfloor wiring or heating. Position the slave door at the closed position. Measure and mark the bottom shootbolt location. Drill a 19mm hole, to a depth of 45mm. For a completely flush finish, a further 27mm hole can be drilled to 3mm deep, centralised over the existing hole. Place the shootbolt keep into the hole and press down into location. A suitable adhesive can be used.

Finish up:

- ▶ Place the cover strips provided into the frame, these sections will clip into the frame profile. If required, these may need to be gently tapped into the profile using a block and rubber mallet.
- ▶ Clean the frame, sashes, and glass with appropriate cleaning solutions.
- ▶ Seal around the outer frame as required.
- ▶ To improve acoustic performance and frame rigidity, expanding foam or foam tape can be used around the frame.
- ▶ Where necessary, the brush gasket can be removed from underneath the door sashes. (e.g. when used with high pile carpet).

Glazing bar:

- ▶ Following installation of the glass, measure and cut the glazing bar to length. Clean the glass and the glazing bar with appropriate cleaning solutions prior to application of the tape.
- ▶ Apply the tape along the length of the glazing bars. Stick the bar onto the glass at the appropriate locations, pressing firmly along the length to ensure good adhesion.

Accreditations...

At Origin, we pride ourselves on providing best quality products backed by best levels of service and efficiency. Put simply, our aim is to continuously learn, evolve and improve.

We are well known for having rigorously high standards in everything that we do. We're also known for innovation, but we never want to settle: if there's a way that we could do something better, we will find it.

This ethos has been instilled throughout Origin. Whether it's a process, product offering or even the company's sustainability, we have created a culture that encourages continuous improvement.

To demonstrate our commitment and as a way of measuring our performance, we work towards gaining certain prestigious accreditations. Our achievements show a strong moral and ethical intent in how we operate and how we try to do things the best way, not because we are told to do so, but because we think it is the right thing to do.

ISO 9001 – Quality Management

ISO 9001 is an international standard that assesses a company's quality management system. Having first achieved it in 2013, the fact that we still are certified means that we have a track record of consistently providing products and services that meet both customer and regulatory requirements.

It's something that we take very seriously and its influence is integrated into every process.

Key areas of this include:

Product quality – To ensure a product's overall manufacture is flawless, we have checks in place to guarantee you the best quality. A few examples are:

- Supply chain – an inspection at the point of delivery and before going into manufacturing. If anything is spotted, it's documented and raised with the supplier.
- Production – there are quality checks at every station, not only to look over the previous person's work, but to review the quality of the overall build.
- Equipment – a robust maintenance schedule for machinery and equipment ensures consistency.
- Pre-delivery – before it is packaged and loaded ready for delivery, there's another thorough check to ensure nothing's happened whilst being moved from station to station.
- Feedback – as part of our mission to always innovate, whether it's from internal or external stakeholders, feedback is imperative. We are very proactive at bringing this type of information back into the business and learning, as it gives us an opportunity to improve.
- Training and development for our employees – meaning we're better at understanding the good, the bad, and what we can do better.



FS 584084

ISO 45001 – Health & Safety Management...

Whether it's through improving homes with our products, or in our workplace, people are at the heart of everything that we do at Origin, so we are very proud to have achieved a triple badge accreditation when we received our latest accolade – ISO 45001.

ISO 45001 recognises our commitment to employee safety, and reduces workplace risks to create a better, safer working condition. We have spent time reviewing all the activities that go on within the offices, manufacturing centres and warehouses, and have created a full risk log which will link up to our current risk assessments. These are fed back so they can be actioned to be rectified or developed into an improved method of operating.

This means that you can buy from our range safe in the knowledge that we are minimising risks as much as we can for optimum safety.



OHS711491

ISO 14001 – Environmental Management...

Now more than ever, we need to be aware of the impact our operations may have on our environment; the legal obligations we must adhere to, and ensuring we are doing things the right way.

The internationally renowned ISO 14001 accreditation measures the environmental management system that we have in place. It's a subject that's very close to our hearts, which is why working towards this standard was an easy decision.

We care about the resources we use for our products – where they come from and where they end up. To add to this, we aim to be zero waste to landfill and have already put into place many positive changes to make this happen. We want our customers to buy from us with a clear conscience and feel that ISO 14001 can prove that Origin is taking responsibility, acting ethically, legally and exercising best practice in all that we do. Our environmental management system covers:

- Waste management and energy targets – to reduce our consumption and impact on the environment

Helpful hints, tips and reminders are prompted to all staff regularly, so that they can join us in our goal and see how small changes to their work practices can have a big impact.

- Product design and lifecycle – recyclability and sustainability are a design priority for us.
- Supply chain – choosing suppliers that are aligned with our ethos and vision. This is applicable not only when bringing on new suppliers, but also working with existing ones to better their carbon footprint – whether that's minimising packaging, reusing or even our drivers picking up the materials on their routes, rather than a supplier sending their own fleet, we are constantly reviewing how we can improve.



EMS 745310

Contact

Accounts

t 08448 802 371 or 01494 416 895 **e** Finance@origin-global.com

Marketing

t 08448 802 374 or 01494 416 897 **e** Marketing@origin-global.com

Sales Operations

t 0808 168 5816 or 01494 686 868 **e** OrdersNorth@origin-global.com

e OrdersSouth@origin-global.com

Fleet and Logistics

t 08448 802 378 or 01494 416 898 **e** Logistics@origin-global.com



Origin Global HQ, Stuart House, Castle Estate,
Coronation Road, High Wycombe
Buckinghamshire, HP12 3TA

t 0808 168 5816
e enquiry@origin-global.com
w www.origin-global.com

